

## Pressure Gauge Accessories

### Throttling Devices

A throttling device should be used when a pressure gauge is subjected to rapid pressure fluctuations, which make the gauge difficult to read because of rapid pointer movement. Such a device reduces pressure impact, slows the speed and range of pointer movement, and prolongs gauge life.

Throttling effect is obtained by installing a restricting orifice between the gauge socket connection and the bourdon tube. Several types are available: throttle screws, pressure snubbers, pulsation dampeners, Gauge Saver® and the Campbell MICRO-BEAN.

Severe service applications are characterized by the presence of significant levels of pressure pulsation and/or vibration. Gauges should be protected from severe pressure pulsation by the inclusion of a dampener such as a throttle plug/screw or porous metal snubber. If the pulsation is extreme, a liquid-filled gauge, with dampener, should be used. A liquid-filled gauge will also last significantly longer than a comparable dry gauge when vibration is present. If the vibration levels are extreme, the only solution may be to remotely mount the gauge away from the source of vibration. In that case capillary tubing may be used to connect the gauge to the pressure source.

### THROTTLE SCREWS

The simplest means of providing a restriction in the socket, a throttle screw, should be ordered with the gauge. Threaded or pressed into an instrument socket, the throttle screw orifice selected is based on the viscosity of the pressure fluid, rapidity of pressure fluctuations, and the amount of dampening effect desired.

A smaller orifice should be used for low viscosities, high frequencies, high

pressure and reduced pointer amplitude. To accommodate these variables, throttle screws are available in these sizes: 0.0135, 0.020, 0.031, 0.040, and 0.070 inches, in brass and stainless steel. When orifice size or service condition is not specified, a 0.020-inch orifice will be supplied on Duragauge® pressure gauges 0.0135, on 25-35 1009 and 63 and 100mm 1008S.

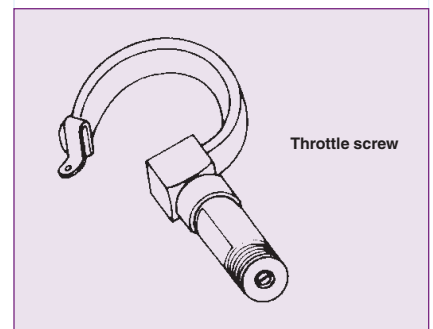

### PULSATION DAMPENER

Threads onto a gauge socket and provides restriction by means of a moving pin, which may be placed in either of five different sized holes, and thus allows the user to vary the amount of dampening to suit requirements. The pulsating pressure moves the pin up and down, providing a self-cleaning action. Dampeners are shipped with a pin in the "middle" hole, and may be used in either a vertical or horizontal position. Maximum pressure is 5000 psi.

| Type Number | NPT Conn. | Material        | Weight (oz.) |
|-------------|-----------|-----------------|--------------|
| 25-1106B    | ¼         | Brass           | 4            |
| 50-1106B    | ½         | Brass           | 8            |
| 25-1106D    | ¼         | Steel*          | 4            |
| 50-1106D    | ½         | Steel*          | 8            |
| 25-1106S    | ¼         | Stainless steel | 4            |
| 50-1106S    | ½         | Stainless steel | 8            |

\* Internal parts are stainless steel.



### PRESSURE SNUBBER

| Type Number | NPT Conn. | Material            |                     | Max psi Rating |
|-------------|-----------|---------------------|---------------------|----------------|
|             |           | Housing             | Filter Disc         |                |
| 25-1112B    | ¼         | Brass               | 316 stainless steel | 10,000         |
| 50-1112B    | ½         |                     | 316 stainless steel |                |
| 25-1112S    | ¼         | 303 stainless steel | 316 stainless steel | 15,000         |
| 50-1112S    | ½         |                     | 316 stainless steel |                |
| 25-1112M    | ¼         | R Monel             | Monel               | 15,000         |
| 50-1112M    | ½         |                     | Monel               |                |

| Porosity | Max Pore Cap. Opening (Inches) | CFH at 1 psi Diff. Press. | For use with                         |
|----------|--------------------------------|---------------------------|--------------------------------------|
| D        | 0.005                          | 6.5                       | Oil (50 to 500 S.S.U.)               |
| E        | 0.0025                         | 3.0                       | Water & Light Oils (Under 50 S.S.U.) |
| G        | 0.0008                         | 1.1                       | Air, Steam and Gases                 |
| HX       | 0.0006                         | 0.4                       | Mercury Manometers                   |

Used for dampening and filtering, the snubber has a metal disc available in four standard grades of porosity. The one best suited for the application can be selected from the chart, using the same guidelines as for throttle screws. Due to the large filter area, the snubber has less tendency to clog than orifice-type devices. All-metal construction permits the snubber to be washed in a variety of common solvents.

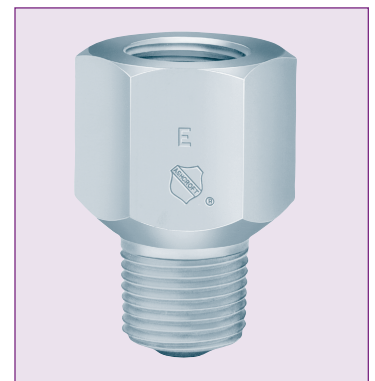

## Pressure Gauge Accessories

### STEEL NEEDLE VALVE

The steel needle valve is an economical, adjustable throttling device for any severe gauge application where the precise adjustment of the Campbell MICRO-BEAN® is not required. It provides the most practical means for varying the orifice to determine the exact orifice for any specific service condition. The valve has an internal seat and is of bar stock construction.

| Dimension – Inches |    |    |          |    |    |            |
|--------------------|----|----|----------|----|----|------------|
| A<br>NPT Conn.     | B  | C  | D – min. | E  | F  | Weight oz. |
| ¼                  | 2⅞ | ⅞  | 2½       | 3  | 3⅞ | 8          |
| ½                  | 2¼ | 1¼ | 2½       | 3⅞ | 3⅞ | 21         |

| NPT Conn. | Type Numbers<br>Lock Bonnet<br>Type Valves | Material                        | Pressure Ratings<br>Noncorrosive Service (psi) |       |       |        |
|-----------|--|---------------------------------|--|-------|-------|--------|
|           |  |                                 | 100°F  | 550°F | 850°F | 1000°F |
| ¼         | 25-7001L                                   | Carbon steel with 12-14% chrome | 10,000   | 7735  | —     | —      |
| ½         | 50-7001L                                   | Stainless steel stem            |  |       |       |        |
| ¼         | 25-7004L                                   | 316 stainless steel             | 7000   | 4500  | 3895  | 3535   |
| ½         | 50-7004L                                   |                                 |  |       |       |        |

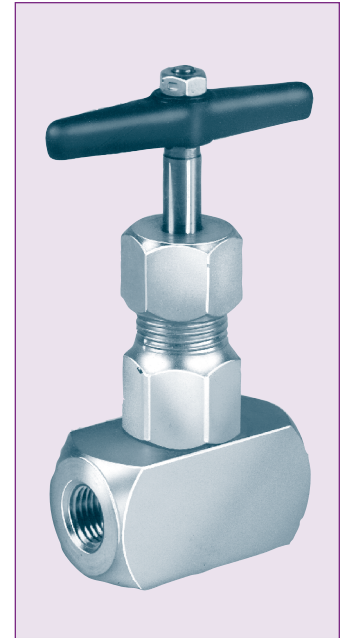
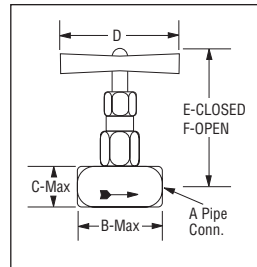

### CAMPBELL MICRO-BEAN

This precision valve has a very long taper on the plug, which will permit precise adjustment of the dampening effect. A filter is built into the valve in order to keep foreign matter from plugging the fine orifice. The MICRO-BEAN is made of 1½" hexagonal bar stock and is 4" in length. Turning the handwheel produces the degree of dampening required.

| Type Number | NPT Conn. | Material            | Weight | Pressure Rating psi |
|-------------|-----------|---------------------|--------|---------------------|
| 25-1110B    | ¼         | Brass               | 2¼ lb  | 3000                |
| 50-1110B    | ½         | Bass                | 2¼ lb  | 3000                |
| 25-1110S    | ¼         | Steel               | 2¼ lb  | 6000                |
| 50-1110S    | ½         | Steel               | 2¼ lb  | 6000                |
| 25-1110C    | ¼         | 303 stainless steel | 2¼ lb  | 10,000              |
| 50-1110C    | ½         | 303 stainless steel | 2¼ lb  | 10,000              |
| 25-1110A    | ½         | 316 stainless steel | 2¼ lb  | 10,000              |
| 50-1110M    | ½         | Monel               | 2¼ lb  | 10,000              |

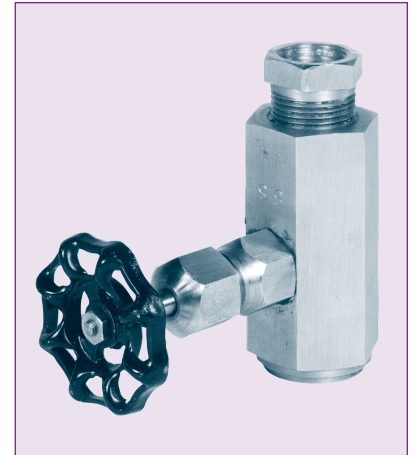

### CHEMIQUIP PRESSURE LIMITING VALVE SNUBBER<sup>(1)</sup>

| Type Number             | Conn.  | Material | Available Ranges          | Style |
|-------------------------|--------|----------|---------------------------|-------|
| 25-255B <sup>(2)</sup>  | ¼ NPTF | Brass    | 10-150 psi <sup>(3)</sup> | 3     |
| 25-255S <sup>(2)</sup>  | ¼ NPTF | 303 SS   | 150-500 psi               | 4     |
|                         |        |          | 500-1000 psi              | 5     |
| 50-2550D <sup>(4)</sup> | ½ NPTF | 316 SS   | 1000-3000 psi             | 6     |

- (1) Cannot be used with Ashcroft diaphragm seals.
- (2) Specify porosity designation.
- (3) Use code XFS for factory setting.
- (4) Meets NACE MR01-75 requirements.

Assures positive, repeatable performance of the instrument by protecting against surges and pulsations. Automatically shuts off when overpressure occurs and is restored when pressure falls below preset values.



## Pressure Gauge Accessories

| CHEMIQUIP PRESSURE LIMITING VALVE <sup>(4)</sup> |            |          |                                  |       |
|--|------------|----------|----------------------------------|-------|
| Type Number                                      | Conn.      | Material | Available Ranges <sup>(3)</sup>  | Style |
| 25-5460  | 1/4 NPTF   | 303 SS   | 100-800 psi                      | L     |
| 50-5500  | 1/4 NPTF   | 303 SS   | 800-2500 psi                     | M     |
| 09-6430 <sup>(1)</sup>                           | 1/4 AMINCO | 303 SS   | 2500-10,000 psi <sup>(1)</sup>   | N     |
|  |            |          | 10,000-18,000 psi <sup>(2)</sup> | O     |

(1) Not available attached to instrument at factory.

(2) Available with model 09-6430 only.

(3) Use code XFS for factory setting.

| Type of Service                                  | Porosity Designations |
|--|-----------------------|
| High viscous fluids (over 500 S.S.U.)            | C                     |
| Oil (225-500 S.S.U.)                             | D                     |
| Water and light oils (30-225 S.S.U.)             | E                     |
| Vapor and low viscosity fluids (Below 30 S.S.U.) | F                     |
| Air or other gases                               | G                     |
| Extreme gas pulsations                           | HX                    |

Protects pressure instruments against surges and pulsations. Provides automatic positive protection and accurate, repeatable performance. Automatic pressure shut-off. Built-in snubber enhances instrument, protecting performance.

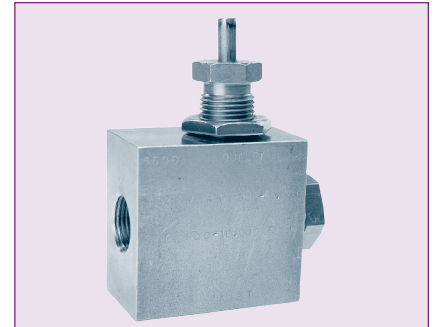

### SIPHONS

In order to prevent live steam from entering a pressure gauge Bourdon tube, a siphon filled with water should be installed between the gauge and the process line. If freezing of the condensate in the loop of a siphon is a possibility, a diaphragm seal should be used to isolate the gauge from the process steam. Also use siphons whenever

condensing hot vapors (not just steam) are present.

- Pig Tail Siphon—Number 1100 Series, 1/4" sizes: to 500 psi and 400°F.
- Coil Pipe Siphon—Number 1098 Series, 1/4", 1/2" sizes: to 9550 psi and 400°F.

| Type Number | NPT Conn. | Material                              | Capacity   |
|-------------|-----------|---------------------------------------|--|
| 25-1098 I   | 1/4       | Iron                                  | 500 psi @ 400°F                                  |
| 25-1098 B   | 1/4       | Brass                                 | 250 psi @ 400°F                                  |
| 25-1098 S   | 1/4       | ASTM A-106 seamless steel, Grade A    | 338 psi @ 1000° to 3360 psi from -20° to 400°F   |
| 50-1098 S   | 1/2       | ASTM A-106 seamless steel, Grade A    | 333 psi @ 1000°F to 3000 psi from -20° to 400°F  |
| 50-1098 SD  | 1/2       | ASTM A-106 seamless steel, Grade A    | 420 psi @ 1000°F to 3740 psi from -20° to 400°F  |
| 50-1098 CD  | 1/2       | ASTM A-213 seamless steel, Grade T 22 | 1048 psi @ 1200°F to 9550 psi from -20° to 400°F |
| 50-1098 NS  | 1/2       | Seamless stainless steel, Type 316    | 294 psi @ 1500°F to 3981 psi from -20 to 100°F   |
| 50-1098 ND  | 1/2       | Seamless stainless steel, Type 316    | 336 psi @ 1500°F 5840 psi from -20° to 100°F     |
| 25-1100 A   | 1/4       | Stainless steel                       | 500 psi @ 400°F                                  |
| 25-1100 I   | 1/4       | Iron – 6 3/8" Long                    |  |
| 25-1100 IL  | 1/4       | Iron – 8" Long                        |  |
| 25-1100 IN  | 1/4       | Iron – Angle                          |  |
| 25-1100 B   | 1/4       | Brass – 5 3/8" Long                   | 250 psi @ 400°F                                  |
| 25-1100 BL  | 1/4       | Brass – 8" Long                       |  |

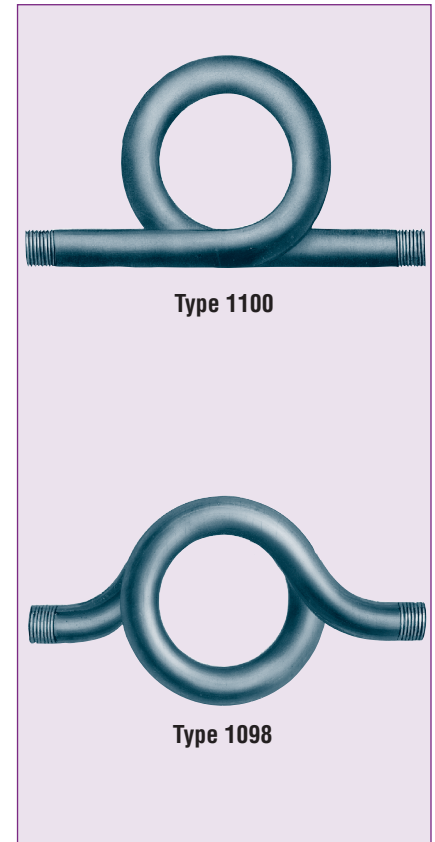

## Pressure Gauge Accessories



### DIAPHRAGM SEALS

Designed for use with pressure gauges or switches or transmitters on process applications where:

- Process element materials capable of withstanding corrosive effects of certain fluids are not available.
- The process fluid being measured would normally clog the pressure measuring element.
- The process fluid in the measuring element might freeze due to changes in ambient temperatures.

A diaphragm assembly fabricated of materials that will withstand various corrosive media encountered, separates the measuring element from the process fluid. Since the space between the diaphragm and the measuring element is solidly filled with liquid, any movement of the diaphragm caused by a change in the process pressure will be indicated by the instrument.

Ashcroft diaphragm seals are normally mounted directly to the socket of an instrument. A flexible stainless steel armored line assembly, is available for mounting the gauge at some point away from the seal location to provide easy reading or to limit the temperature at the gauge to 150°F maximum.

Diaphragm seals (isolators) with filled, capillary line assemblies are another good solution to the problem of hot liquid and gas lines. Due to the small diameter of the flexible line (capillary) a five foot line length will usually assure that the temperature of the gauge connection does not exceed 150°F. This solution is also superior to a siphon on steam service where the water filled siphon might freeze.

## Pressure Gauge Accessories

### ELECTRIC WARNING CONTACTS

The Ashcroft® 2265 electric contact is an ideal accessory to turn on a signal light, sound an alarm, or operate a pump or valve. The contacts can easily be set so that a circuit can be closed or opened at a desired pressure or temperature.

Settings can be easily made in the field without removing the instrument from service. Contact adjustment is made externally with a removable key to make the instrument virtually tamper proof.

The contact is designed for easy installation on Types 1279, 1377 and 1379 Duragauge pressure gauges (either stem or flush mounted), Type 1125 differential pressure gauges, or Type 600A Duratemp dial thermometers.

Contacts are equipped with adjustable magnets to eliminate chatter caused by vibration. A plug-in connector with five feet of electrical cable is standard.

| Use with Ashcroft Model No. | Description    | Availability         |                  |          |                  |
|-----------------------------|----------------|----------------------|------------------|----------|------------------|
|                             |                | Code                 |                  | Mounting |                  |
|                             |                | 45<br>4 1/2"<br>Dial | 60<br>6"<br>Dial | Stem     | Flush            |
| 1279                        | Duragauge      | X                    | —                | X        | X <sup>(1)</sup> |
| 1377                        | pressure gauge | X                    | X                | —        | X                |
| 1379                        | gauge          | X                    | X                | X        | X <sup>(1)</sup> |
| 1125                        | D/P gauge      | X                    | X                | X        | X                |
|                             |                |                      |                  | Surface  | Flush            |
| 600A-02                     | Duratemp       | X                    | X                | —        | X                |
| 600A-03                     | remote         | X                    | X                | X        | X                |
| 600A-04                     | thermometer    | X                    | X                | X        | X                |

<sup>(1)</sup> Flush mounting requires type 1278 flush mounting ring.  
All specifications are subject to change without notice.

| Model | Code | Contact arrangements                       |
|-------|------|--|
| 2265  | XED  | High and low contact                       |
|       | XEE  | Double high contact                        |
|       | XEF  | Double low contact                         |
|       | XEG  | "OFF" at low and high, and "ON" in between |



Indicating accuracy of Ashcroft Duragauge, above 300 psi with contact: Pointer not carrying contact – 1.0%.  
Pointer carrying contact – 1.5%. For ranges below 30 psi, add an additional 1/2% to indicating accuracies.

### CONVERSION KIT

For field converting 4 1/2" 1279(\*)S and 4 1/2" and 6" 1379(\*)S Duragauge® gauges to a sealed case design suitable for either hermetic sealing or liquid filling. Kit includes (Typical A1280 kit shown):

- O-ring for front case seal.
- Acrylic window.
- Elastomeric diaphragm (Buna-N) for rear case seal.
- Glass filled polypropylene threaded ring for rear of case.
- 302 stainless steel rear cover and mounting screws.
- 303 stainless steel and Monel throttle screws.

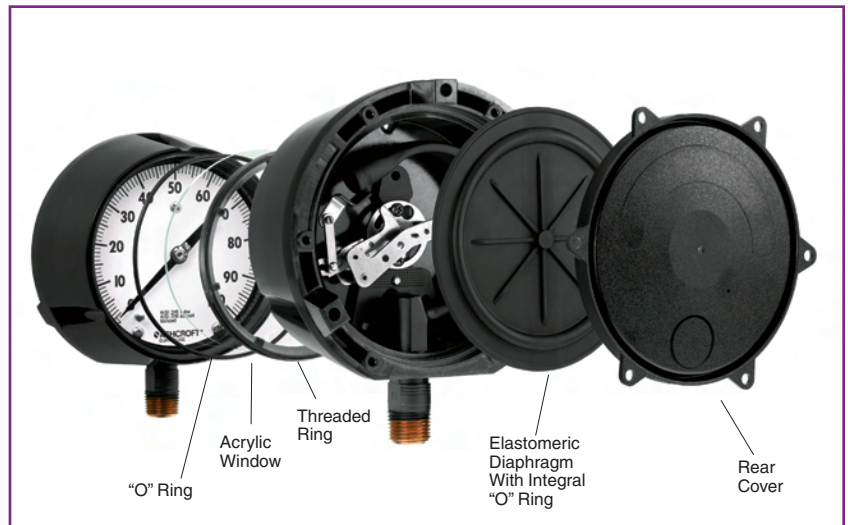

### HOW TO ORDER THIS CONVERSION KIT

FOR:

- 4 1/2" 1379, lower connected – order type A1280 Kit.
- 4 1/2" 1379, back connected – order type A1283 Kit.
- 4 1/2" 1279, lower connected – order part no. 101A202-01.
- 4 1/2" 1279, back connected – order part no. 101A2023-01.
- 6" 1379, lower & back connected – order type A1284 Kit.

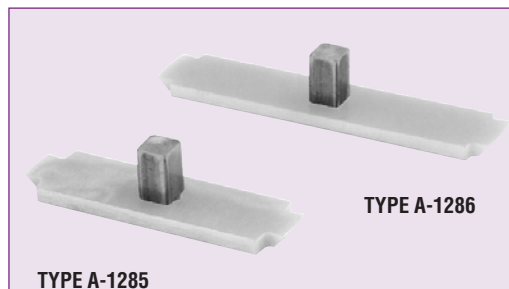

### TYPE A-1285

#### Ring Wrench – 4 1/2"

(For installing front threaded rings in 4 1/2" Duragauge gauge)

### TYPE A-1286

#### Ring Wrench – 6"

(For installing front threaded rings in 6" Duragauge gauge)

## Pressure Gauge Accessories

### TYPE A-1287

#### Cone Tool

For installing diaphragm and garter spring on back connected liquid-filled or hermetic sealed Duragauge® gauges.



TYPE A-1287

### TOOLS

**Hand Jack Set** – gauge pointer remover and a pointer set to secure pointer to the shaft. Type No. 3220.

**Ring Removal** – For the 2½" and 3½" 1009 gauge. Includes 2½" and 3½" wrench and nest. Type No. 1206T.

**Small Tools** – For the 2½" and 3½" 1009. Includes pointer puller, span adjust wrench, slotted screw driver for pointer adjustment, pointer staker and pinion backup. Type No. 1205.

**Gauge Tool Kit** – A complete kit for gauge maintenance. Includes hand jack set, screw driver, five reamers, pin vise holder, wiggler and tweezers all packed in a neat carrying case. Ideal for a gauge maintenance shop. Type No. 1105T.

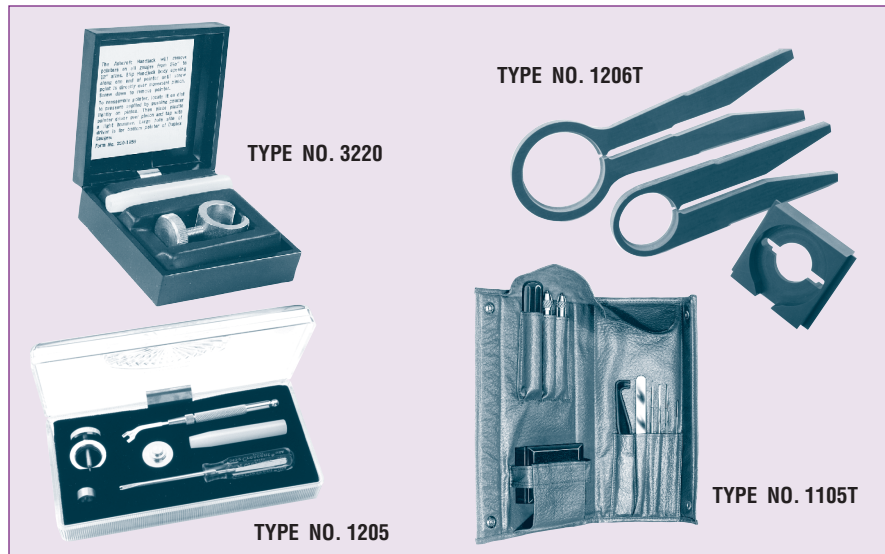

### COCKS

- ¼" brass Tee Handle Cock No. 1092 – Wgt. 3 oz.
- ¼" brass Lever Handle Union Cock No. 1094 – Wgt. 10 oz.
- ¼" brass Lever Handle Cock No. 1095 – Wgt. 4 oz.
- All rated 100 psi air.

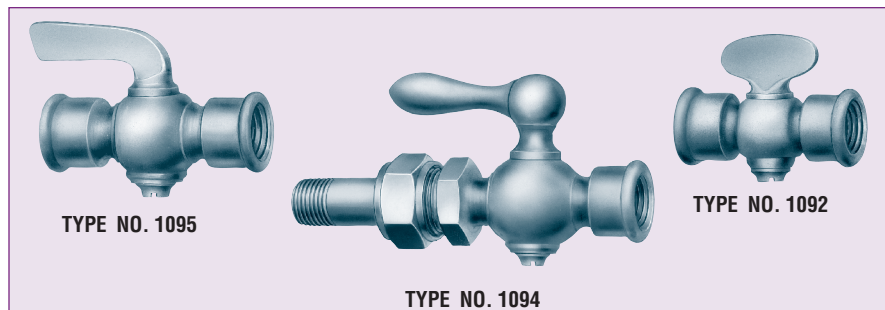

### TEST GAUGE CARRYING CASE

This rugged blow-molded high-density polyethylene carrying case accommodates the standard 4½", 6 & 8½" Ashcroft Type 1082 analog test gauge. It accepts both lower and back connect gauges. A foam insert protects the gauge when not in use. Type No. 2505.

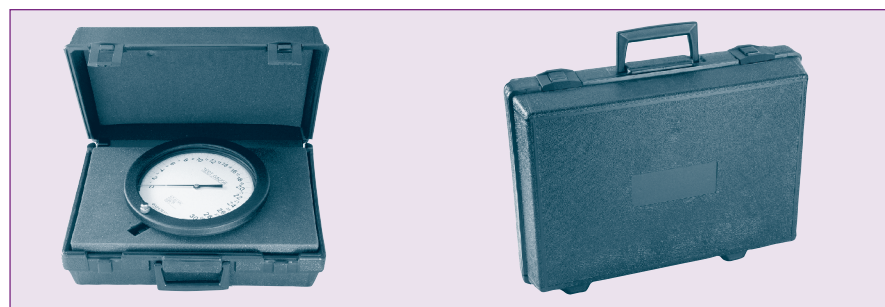

## Process, Stainless Steel, Test and Industrial Pressure Gauge Options

| CODE | DESCRIPTION   | PRESSURE GAUGE TYPE |                      |       |                    |             |                  |                 |
|------|---|---------------------|----------------------|-------|--------------------|-------------|------------------|-----------------|
|      |   | DURAGAUGE GAUGES    | STAINLESS STEEL CASE |       |                    | TEST GAUGES | INDUSTRIAL GAUGE |                 |
|      | 1009 (2 1/2", 3 1/2")                               |                     | 1009 (4 1/2", 6")    | 1008S |                    |             | GENERAL SERVICE  | SPECIAL SERVICE |
| XLL  | <b>PLUS!</b> Performance                            | ●                   | ●                    |       | ● <sup>(1)</sup>   |             |                  |                 |
| XNS  | <b>PLUS!</b> Performance – Silicone Free            | ●                   | ●                    |       | ●                  |             |                  |                 |
| XBF  | Wall mounting bracket                               |                     |                      | ●     |                    |             |                  |                 |
| XFW  | Back flange   |                     | ●                    |       |                    |             |                  |                 |
| XFF  | Front flange  |                     | ●                    |       | ●                  |             |                  |                 |
| XUC  | U-clamp   |                     | ●                    | ●     |                    |             | ●                | ●               |
| XLJ  | Dry liquid-fillable gauge                           | ●                   | ●                    | ●     | ●                  |             |                  |                 |
| XOS  | Overload stop                                       | ●                   | STD                  | ●     | STD <sup>(1)</sup> | STD         | ●                | ●               |
| XVS  | Underload stop                                      | ●                   | STD                  | ●     | STD <sup>(1)</sup> | STD         | ●                | ●               |
| XTS  | Throttle screw                                      | ●                   |                      | ●     | ●                  | ●           | ●                | ●               |
| XTU  | Throttle plug                                       |                     | ●                    |       | ●                  |             |                  | ●               |
| XS4  | Slotted link movement (decrease)                    | ●                   |                      | ●     |                    |             | ●                | ●               |
| XRJ  | Slotted link (increase)                             | ●                   |                      | ●     |                    |             | ●                | ●               |
| XAP  | Adjustable pointer                                  |                     | ●                    | ●     |                    |             | ●                | ●               |
| XMP  | Micrometer pointer                                  | STD                 | ●                    | ●     |                    |             | ●                | ●               |
| XSH  | Red set hand stationary                             | ●                   | ●                    | ●     |                    |             | ●                | ●               |
| XEO  | Red set hand adjustable                             | ●                   | ●                    | ●     | ●                  | ●           | ●                | ●               |
| XEP  | Maximum pointer                                     | ●                   |                      | ●     | ●                  | ●           | ●                | ●               |
| XEQ  | Minimum pointer                                     | ●                   |                      | ●     | ●                  | ●           | ●                | ●               |
| XPD  | Plastic window                                      | ●                   | STD                  |       | STD <sup>(2)</sup> | ●           | ●                | ●               |
| XSG  | Safety glass  | ●                   | ●                    | ●     | ●                  | ●           | ●                | ●               |
| XMG  | Metric version gauge                                |                     | ●                    |       | ●                  |             |                  |                 |
| XRG  | Regular glass                                       | STD                 |                      | STD   |                    | STD         | STD              | STD             |
| XDA  | Dial marking  | ●                   | ●                    | ●     | ●                  | ●           | ●                | ●               |
| XNN  | Paper tag   | ●                   | ●                    | ●     | ●                  | ●           | ●                | ●               |
| XNH  | Stainless steel tag                                 | ●                   | ●                    | ●     | ●                  | ●           | ●                | ●               |
| XAB  | Absolute pressure                                   | ●                   |                      | ●     |                    |             | ●                |                 |
| XAJ  | 1/2% optional accuracy                              | STD                 |                      | ●     |                    |             | ●                |                 |
| XAN  | 1% optional accuracy                                |                     | STD                  | STD   |                    |             | STD              | ●               |
| XRA  | Retard scale  | ●                   |                      | ●     |                    |             | ●                |                 |
| XWN  | White dial  | STD                 | ●                    | ●     | STD                | STD         | ●                | ●               |
| XBD  | Black dial  | ●                   | ●                    | ●     | ●                  | ●           | ●                | ●               |
| X6B  | Oxygen-cleaned gauges (gaseous)                     | ●                   | ●                    | ●     | ●                  | ●           | ●                | ●               |
| XTB  | Tip bleed   | ●                   |                      |       |                    | ●           |                  |                 |
| XED  | High and low electric contacts                      | ●                   |                      |       |                    |             |                  |                 |
| XEE  | Double high-electric contacts                       | ●                   |                      |       |                    |             |                  |                 |
| XEF  | Double low-electric contacts                        | ●                   |                      |       |                    |             |                  |                 |
| XEG  | Electric contacts off at low or high and in-between | ●                   |                      |       |                    |             |                  |                 |
| XGV  | Silicone-filled gauge                               | ●                   | ●                    | ●     | ●                  |             |                  |                 |
| XGX  | Halocarbon-filled gauge                             | ●                   | ●                    | ●     | ●                  |             |                  |                 |
| XCH  | Carrying handle                                     |                     |                      |       |                    | ●           |                  |                 |
| XC4  | Calibration Chart                                   | ●                   | ●                    | ●     | ●                  | ●           | ●                | ●               |

### NOTES:

The options listed above are only a partial listing.  
For other options on these or other pressure instruments  
please call the factory for availability.

(1) Available on 63mm and 100mm.

(2) Available on 40mm and 50mm.

## Pressure Gauge Accessories



**Stationary Red Set Hand**  
to indicate a specific pressure. Ring must be removed to move the hand.

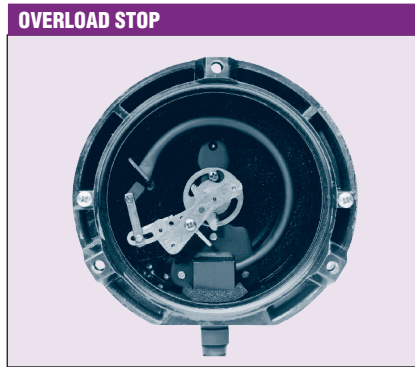

**Overload Stop**  
to protect gauge system against extreme overpressure.

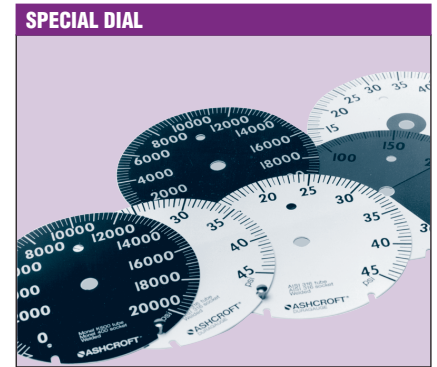

**Special Dial**  
ranges different from standards, or custom artwork, available on application.



These bleeders allow trapped air to be removed from the bourdon tube. They can also be used for back-flushing or cleaning the system. The tip bleed is available with 316 stainless steel systems. It is accessible by removing the pressure relief back. Tip bleeders are available to 23,000 psi. The capillary bleeder provides an external case connection to the internals

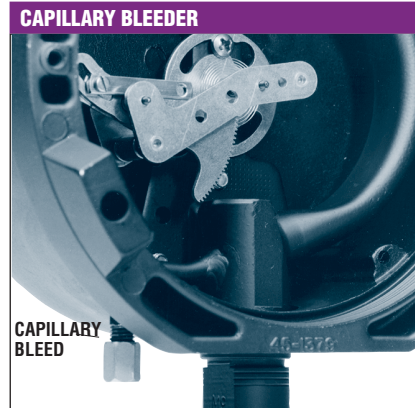

of the Bourdon tube. It may be used as a pressure testing tap for gauge inspection without removing the gauge from service. Capillary bleeders are available in bottom connected gauges only. The capillary bleeder is available in 300 Series stainless steel and limited to 4 1/2" 1379(S)S case with 316 stainless steel system. Capillary bleeders are available to 1000 psi.

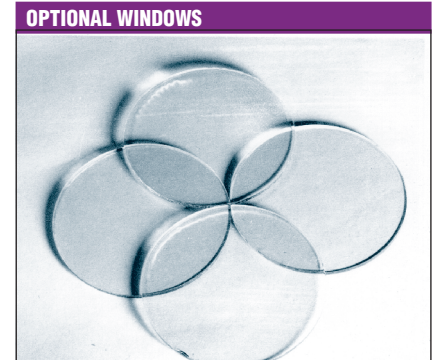

**Plastic Disc** – optional for glass window  
**Laminated Safety Glass** – optional for glass window  
**Nonglare Glass** – optional for glass window

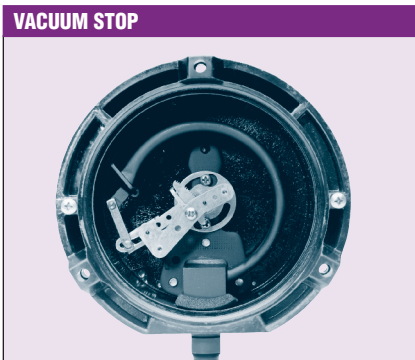

**Vacuum Stop**  
to protect low range gauges against vacuum.

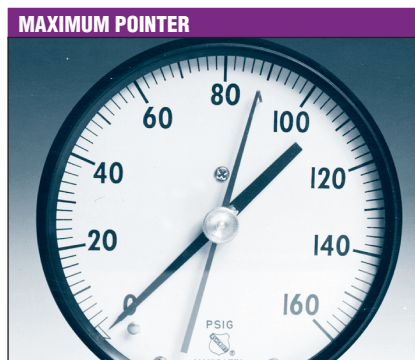

**Maximum Pointer**  
available for gauges 4 1/2" size and larger. Indicates maximum pressure attained. Can be reset by a knob on outside of window.

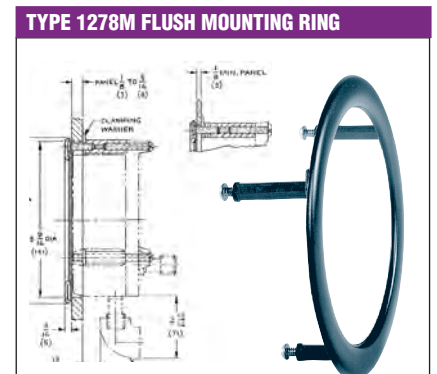

| Gauge Size (inches) | Ring O.D. (inches) | A Dia. (inches) | "B"-Three Screws |
|---------------------|--------------------|-----------------|------------------|
|                     |                    |                 | Size             |
| 4 1/2               | 6.000              | 5.625           | #10-24 x 1 1/8"  |
| 6                   | 7.765              | 7.25            | 1/4"-20 x 1 1/2" |

Used to flush-mount gauge types 1188, 1220, 1279 and 1379. Standard finish is black; polished stainless steel finish is available at an extra charge, 4 1/2" and 6"